

C7 PRO

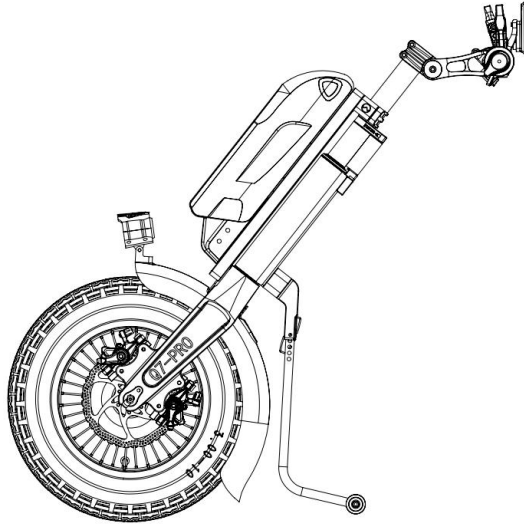

MANUAL

Please read and follow all instructions in this owner's manual before attempting to operate your trailer for the first time. If there is anything you do not understand about this manual, or if you require additional assistance for set-up, please contact your authorized WISKING provider.

Using your WISKING product safely depends on your diligence in following the warnings, cautions, and instructions in this owner's manual. It also depends upon your own good judgment and/or common sense, as well as that of your provider, care giver, and/or healthcare professional. WISKING is not responsible for injuries and/or damage resulting from any person's failure to follow the warnings, cautions, and instructions in this owner's manual. WISKING is not responsible for injuries and/or damage resulting from any person's failure to exercise good judgment and/or common sense.

The symbols below are used throughout this owner's manual to identify warnings and cautions. It is very important for you to read and understand them completely.

Warning! Failure to pay attention to the warnings in the manual may result in C7 PRO"damage and personal injury.

Warning! Wisking Company does not assume liability or accidents arising from the damage and damage caused by the use of product.

Note! Prompt the user to be aware of things that may damage your C7 PRO

TABLE OF CONTENTS

I . INTRODUCTION.....	3
II、 Product structure and parameters.....	4
III. YOUR TRAILER.....	5
(I) HEAD.....	5
(II) Key function description.....	5
(III) 3.1 inch color display description.....	6
(IV) Adjust the head angle.....	7
IV、 INSTALL METHOD.....	8
(I) INSTALL HEAD.....	8
(II) INSTALL CONNECTION PART.....	9
I .NORMAL INTERMEDIATE CONNCTION.....	9
II.NORMAL TWO-SIDES CONNCTION.....	12
III.NEW QUICKLY CONNECTION.....	14
IV.NEW SPEEDY CONNECTION.....	16
V . BATTERIES AND CHARGING.....	18
VI. Maintenance	21
VII. Safety driving important matters.....	23
VIII. WARRANTY.....	24

I . INTRODUCTION

Welcome to Wisking Electric Machine Co., Ltd. (Wisking) . Congratulations on the purchase of your new Wisking Trailer. Your trailer design combines the most advanced state-of-the-art components with modern, attractive styling. We are sure that the design features and trouble-free operation will add convenience to your daily living and ensure complete satisfaction.

At Wisking, your safety is the most important to us. Please read and follow all of the instructions in this manual before you attempt to operate your trailer for the first time. These instructions were produced for your benefit. Your understanding of these instructions is essential for the safe operation of your new Wisking Trailer.





Wisking is not liable for damage to property or personal injury arising out of the unsafe use of Wisking Trailer, Wisking is also not liable for any property damage or personal injury arising out of the failure of any person and/or user to follow the instructions and recommendations set forth in this manual or any other instructions or recommendations contained in other trailer related literature issued by Wisking or contained on the Wisking Trailer itself.

To the publication up to, this manual translated the newest technology standard and the product information. We withhold this manual of the explanation and the revision right. It is possible that there will be slight difference between any change of our product and the illustration of the manual the explanation and the product which you have purchased. If you meet any questions which you can't solve while you using the " Trailer (" safely, or while you think according to the instruction and/or the recommendation method which according to the manual provides are unable to carry on the safe operation, you all may seek the help from the local dealer of the WISKING.

If you have some advice or request, please contact us by telephone, fax or leave the message on our website .We appreciate your advice and we will continue to improve ore quality and enhance our service ,let us enter into the friendship with the communion, Wisking will be your good friend for ever.

Company	Shanghai Wisking Electric Machine Co., Ltd		
Factory	No.168 Ping Gang Road, Situan Town , Fengxian District, Shanghai, China		
address	Tel :	17706285329	Fax : 021-51012038
	E-mail :	wiskingjacky@126.com	
Website	www.wisking.cn		

II、 Product structure and parameters

			
NORMAL INTERMEDIATE CONNECTION	NORMAL TWO-SIDES CONNCTION	NEW QUICKLY CONNECTION	NEW SPEEDY CONNECTION
FIT FOLDING WHEELCHAIR	FIT RIGID WHEELCHAIR		FIT RIGID WHEELCHAIR,NEED TWO BEAMS



PRODUCTS STRUCTURE

TIRE:	16 INCH	BATTERY:	48V/16AH LI-ION
MAX SPEED:	25KM/H	RANGE:	25 ± 5KM (Different according to each person's road situation, slope, wheelchair situation, weight, wind, road conditions and other influences)
Motor:	800W	Weight:	8.5KG not including battery and connection part

With the progress of market demand and technology, your C7 PRO may have small differences with the above performance parameters, which will not have much impact on your use of the product. Wisking reserves the right not to notify the customer of any changes in shape or structure due to technological changes. If you want to know about the latest model or the latest revision, please call wisking, or send an email or browse the Internet.

III、YOUR TRAILER

(I) HEAD



(1) **Electromagnetic brake:** use electromagnetic brake, there is a brake self-locking buckle.

(2) **Horn Switch**

This button activate a warning horn

1. The key must be fully inserted into the key switch for the horn to be operational.
2. Do not hesitate to use the warning horn when you feel its use will prevent accident or injury.

(3) **Electric brake**

(4) **On/Off, Light, Gear Shift and Menu button**

how to operate please read "II. Function description of integrated waterproof button ".



(5) **Color Display**

Read the "III. 3.1 inch Color Display" for this procedure.

(6) **Speed throttle.**

II. Function description of integrated waterproof button







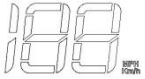

1.  KEY: On-off key Long  key: Power on/off in 3 seconds.
2. **+ key:** Gearshift key
Press the + key : add file
Press and hold the + key : turn on/off the headlights.
3. **-键:** Shift key
Press the - key : reduce the file
Press and hold the - button : switch to reverse mode
4. Function menu Settings
Press the + key and the - key at the same time to enter the function menu. Short key to switch function options, press + or - key to set the corresponding parameter value. After the Settings are complete, press the + and - keys at the same time to exit.

III. YOUR TRAILER

III. Color display



1		Speed and energy display up to 199KM/H.
2		From the bottom to the top, the power level increases in turn, the bottom side of the display cell represents low power, the top side of the display cell represents high power. The right side displays the corresponding percentage of remaining power (percentage display)
3		Display: total mileage, single mileage, real-time voltage display, running time warning, fault warning, rotary voltage value
4		ECO: indicates the non-zero startup mode NORMAL: indicates the zero boot mode
5		Gear display P gear: reverse gear 1st gear: Minimum speed 2nd gear: Intermediate speed 3rd gear: Top speed
6		From left to right, the display functions are: cruise mode, 6KM boost mode, headlight on prompt, USB charging prompt, Bluetooth connection status prompt
7		Fault status display area The number corresponding to the multi-function area represents the corresponding fault content specific status as follows

III. YOUR TRAILER

Trailer status meaning code:

Status code	Status meaning
ERRO 1	MOTOR ERROR
ERRO 2	THROTTLE ERROR
ERRO 3	CHROLLER ERROR
ERRO 4	ELECTRONIC BRAKE ERROR
ERRO 5	LOW-VOLTAGE PROTECTION
ERRO 6	CONNECTION ERROR , THE CONTROLLER CAN' T RECEIVE THE OUTPUT
ERRO 7	CONNECTION ERROR , THE CONTROLLER CAN' T RECEIVE THE OUTPUT 0

IV、 Adjust the head angle



FIGURE 4 Adjust the head angle

The trailer head can be adjusted upward or downward:

1. Use the #5 hex socket screw to loosen (the screw does not need to be completely unscrewed, only need to loosen to the extent that the Angle can be adjusted);
2. Adjust the handlebars up or down to the desired Angle;
3. Tighten the screws.

IV. CONSTRUCTION

(1) INSTALL HEAD PART

INSTALLATION PROCEDURE (The images in this section are only schematic, and some content may not be applicable due to product updates or customization)



STEP 1: Put the support tube on the corresponding pipe and tighten the top wire.



STEP 2: Adjust the tire and head to the vertical position and tighten the two screws with the #5 Allen wrench. Here can not tighten first, later can adjust the head Angle.

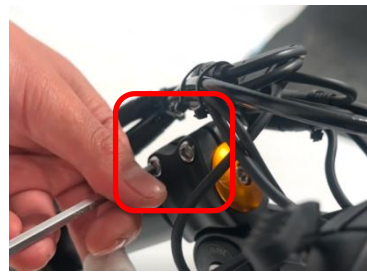

STEP 3: Align the battery with the battery card slot and sit down in the battery base. When you hear a "click" the battery is installed in place.

IV. ADJUSTMENT

(2) INSTALL CONNECTION PART

1、INSTALL NORMAL INTERMEDIATE CONNECTION



STEP 1: Use the #5 hex socket to hold the bridge tube on both sides of the wheelchair to ensure the same position and do not tighten first.



STEP 2: Insert the quick release pin after connecting the middle group to the hole of the upper bridge pipe holder.

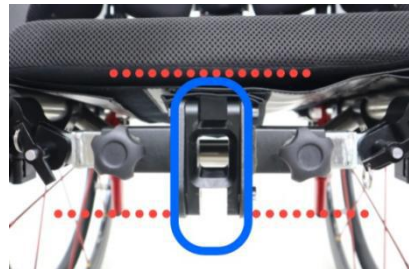

STEP 3: Adjust the horizontal position of the middle connection group, the height is not higher than the seat plate, the square mouth is in the center position, and then lock all screws on the frame connection group.



STEP 4: Insert the hook connection group into the mouth

IV. INSTALL METHOD

ADJUST HOOK CONNECTION PART

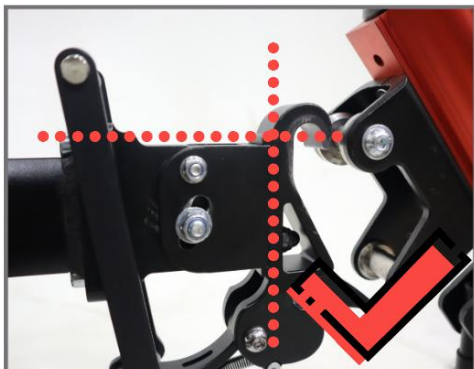

NOTICE:

1. The center of the hook should be about 5 mm higher than the hook column
2. Angle of hook head should be perpendicular to the ground



HEIGHT ADJUST:

Use the #6 hex to loosen the four screws on both sides of the square socket, move them up and down to the appropriate position, and tighten them

Hook head height adjustment

Use the #5 hex and #10 wrench to loosen the 4 screws on the diagram.

First connect the front of the wheelchair, then turn up and down, observe the height of the front wheel off the ground to the appropriate position, and tighten it



4) Targeted adjustment after seating



After the trailer is installed, the trailer can be connected to the wheelchair. In this process, the head handle may touch the leg, the front wheel is not high enough and other problems, which can be adjusted one by one according to the way described in this guide.

IV. INSTALL METHOD

Here are the adjustment positions not covered earlier:

1. Make sure that the support foot does not touch the foot pedal and adjust the distance between the trailer and the person

-- Hook connection length adjustment

2. Touch their feet after seating

-- Stand Angle/head height/foot height/head turning Angle



Length adjustment of hook connection part

Use #4 hex to adjust length



Adjust the head Angle

Use #5 hex to adjust the Angle



Head handle Angle adjustment

Use #5 hex to adjust the Angle



Support foot height adjustment

Unscrew the top wire, adjust the height of the strut, and tighten again



WARNING! It is important to ensure that all screws on the handbike are tightened before driving.

WARNING! Prevents high-speed turning and turning sideways.

IV. ADJUSTMENT

2、INSTALL NORMAL TWO-SIDES CONNECTION

1) Product introduction

ADJUST CONNECTION WIDTH :

Figure 5, loose the screws at A and B, the linear distance between C and D can be changed to adapt to wheelchairs of different widths. (The width here refers to the distance of the front section of the bridge tube of the wheelchair . After the adjustment is appropriate, the screws A and B must be locked, and this operation only needs to be adjusted once, unless the wheelchair is replaced.)

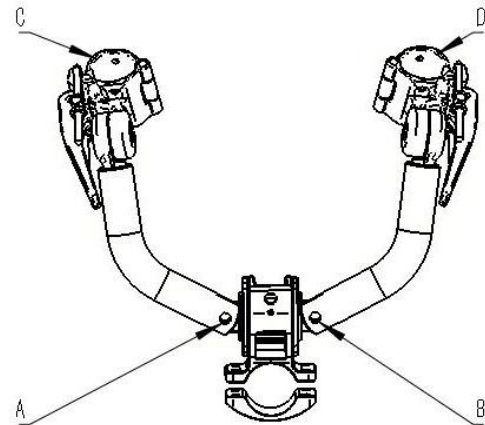

FIGURE 5

ADJUST CLASP SIZE:

Use an open wrench to adjust the nut on the U-shaped round steel (Figure 6) to change the length of the U-shaped round steel and change the size of the clasp.

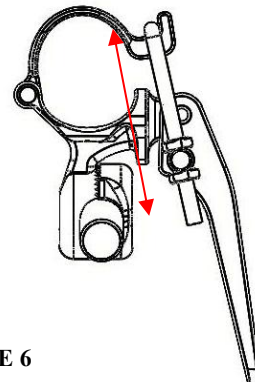

FIGURE 6

ADJUST CLASP ANGLE:

The head clasp assembly is connected to the connecting arm through threads. Use an Allen wrench to loosen the screw, pull the Angle adjusting block, and then lock the screw after changing the Angle.



FIGURE 7



Figure 8 Before (left) and after (right) adjustment

IV. ADJUSTMENT

2) Installation steps (The pictures in this section are only schematic, some content may not be applicable due to product updates or customization)



STEP 1: Hold the red screw with one hand, lift the connecting part with the other hand, pull the connecting part to the horizontal position of the wheelchair, and release the red screw.



STEP 2: Place the driving head on the same plane as the wheelchair, and tighten the black screw (after tightening, the subsequent installation does not require a hand to hold the connecting mechanism, which is convenient for installation).



STEP 3: Clasp the wheelchair bridge tube, tighten the screws. (the clamp on both sides at the same level.)



STEP 4: Loosen the black fixer screws for the next step.



STEP 5: Grab the head with both hands and lift the head upward to the appropriate position, tighten the black tight screw.



STEP 6: Check the wheelie height of the wheelchair so that the wheelie height of the wheelchair is greater than 5cm.

WARNING! Make sure the screws are tight before driving.

WARNING! Please fasten your seat belt.

WARNING! Prevent turning at high speed.

IV. ADJUSTMENT

3、NEW QUICKLY CONNECTION ((The pictures in this section are only schematic, some content may not be applicable due to product updates or customization)

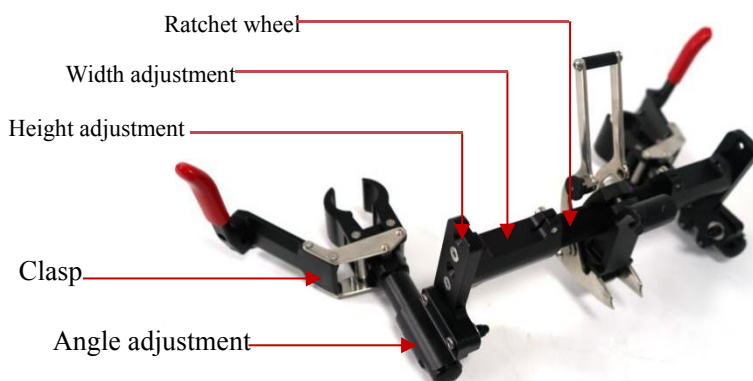

STEP 1: The connecting part is in a state that lightly touches the top wire but does not hook

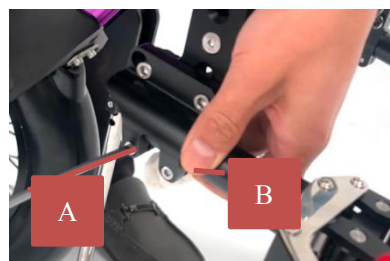

STEP 2: Use # 4 hex socket to loosen 4 screws A and B.

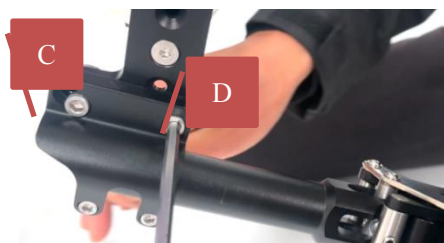

STEP 3: Use the # 5 hex and wrench to loosen 4 screws around C and D.

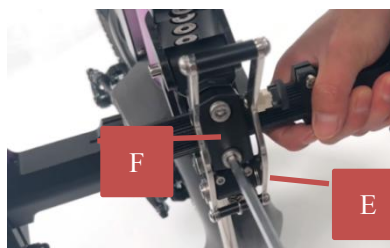

STEP 4: Use #6 hex to loose the two screws at E and F.

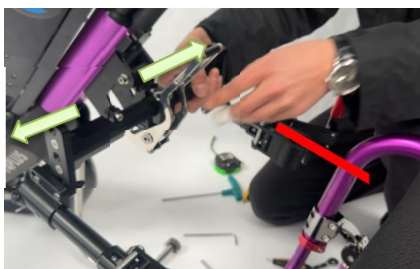

STEP 5: After leveling the wheelchair with the bridge tube, fix the screws E and F at the ratchet, ensuring that the ratchet is in the center position.



STEP 6: Use #5 hex to loose Loosen the two screws at G and H.

IV. SET-UP



STEP 7: Connect the link part with wheelchair tube, ensure enough width, the position of the bridge tube should be in the same horizontal position.



STEP 8: Pay attention to the fit degree (tightness) of the clamp and the bridge tube. If it is too loose or too tight, the # 6 hex can be rotated inward or outward.

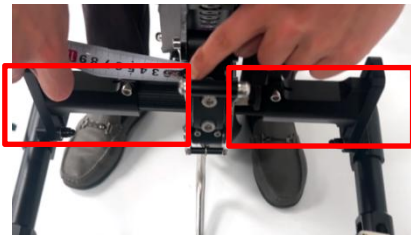

STEP 9: Use a ruler to measure whether the ratchet sizes on both sides are consistent, and tighten the 2 screws at G and H after they are consistent.



STEP 10: Adjust the distance between the forearm and the wheelchair, after measuring the same distance on both sides with A ruler, you can tighten the screws at A, B, C, D, E and F.



STEP 11: All the screws are screwed, it is adjusted, you can lift the front, hear a "click" is the card in.



STEP 12: After the card is in place, pull the safety pin to the locked state to prevent miscontact while driving.



STEP 13: After installation, check the height of the front wheel from the ground, about 3cm is appropriate.

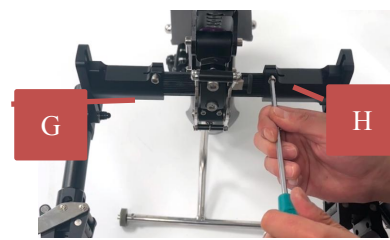

STEP 14: To adjust the ground height of the front pinion, turn the ratchet in Step 4.

IV. SET-UP

4、NEW SPEEDY CONNECTION (The pictures in this section are only schematic, some content may not be applicable due to product updates or customization) 车头连接部分

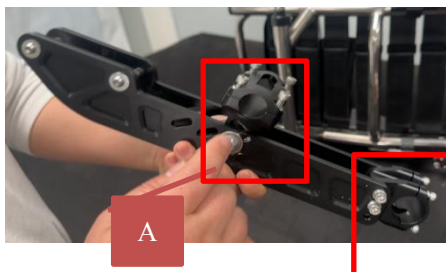
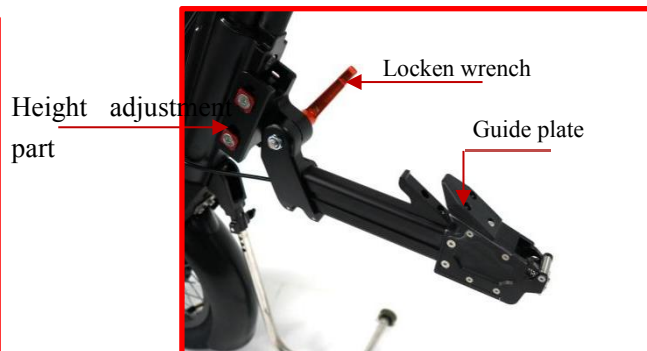
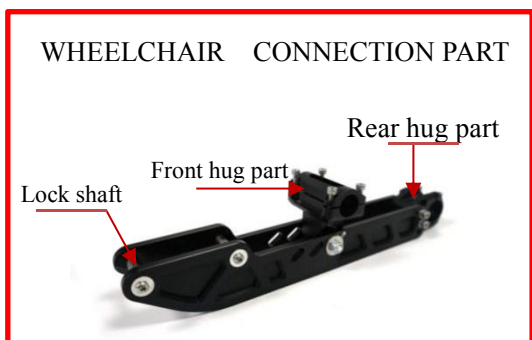

STEP 1: Unscrew the grip screws on the front and rear hug parts. The screw A referred is loosened so that it is in a movable state.



STEP 2: Determine the center distance between the two beams of the wheelchair to ensure the distance between the wheelchair connection part.

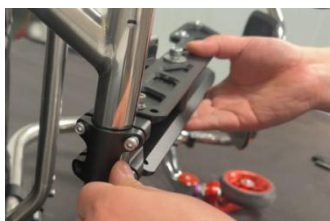

STEP 3: Use #4 hex to screw the rear hug part, which are pre-installed here. Do not tighten them.



STEP 4: Use #4 hex to screw the front hug part, which are pre-installed here. Do not tighten them.



STEP 5: After pre-installation, use a ruler to measure the distance between the rear hug part and the beam, and make sure that the rear hug part is in the center position, alternately screw 4 screws, and do not tighten screws here.



STEP 6: Hang the connection part of the wheelchair and the front hug part, and check the wheelchair-front wheel height at this time. Because the front hug in Step 4 is not tight, the front wheelie height can be adjusted directly by pressing or lifting.

IV. SET-UP



STEP 7: If the front pinion lift cannot be adjusted in Step 6, adjust the holes at the screws referred to in A.



STEP 8: The height of the front wheel off the ground is about 3-4cm. After determining the height, tighten the screws on all the wheelchair connections. Includes the 8 screws on the front and rear cradles and the screws referred to in A. (If your wheelchair has a hard seat, remove the seat)



STEP 9: Loosen the connection mechanism, put the wheelchair connection part and the front connection part together, check the position of the lock shaft and the guide plate, the suitable position is: the guide plate is about 5mm higher than the lock shaft. If no, perform Steps 10 and 11 to adjust the position.



STEP 10: Loosen B, C and their corresponding screws on the height adjustment part, a total of 4, can move the front connection mechanism up and down, adjust to the appropriate position, tighten these 4 screws.



STEP 11: If Step 10 is not enough, adjust the leg holes. The installation is complete when the position is adjusted properly.

V. BATTERIES AND CHARGING

1. Battery model

Type: lithium battery

Voltage: 48v

Ampere: 18Ah

Battery lock key

Battery level display

- Press the button below to display the remaining power

--Battery charging port
-USB interface

2. Removing/installing the battery

- 1). Turn off the power;
- 2). Open the battery lock key;
- 3). Take out the battery in the direction indicated by the arrow;
- 4). Install the battery: along the battery slot, facing the battery base, clamp the battery down to ensure that the connection is tight.



Figure 9 Removing the battery



Warning! The battery support frame, plug and related accessories include cable and cable connector. Please wash your hands after touching.

Warning! Do not pull out the battery by force, otherwise the battery contact may be damaged..

CHARGING YOUR BATTERIES

The battery charger is one of the most important parts of the handbike, and the C7 charger is optimized to make battery charging faster and easier.

Ready to charge:

- 1, put the charger's metal plug (i.e. Figure 9. End A) is connected to the battery's power input hole;
- 2, Plug the other end of the charger (i.e. Figure 9. End B) access to 110 volts or 220 volts;
- 3, Then the charger light is red Light Turn green Indicates that the charge is full

(The specific light change is subject to the physical charger)

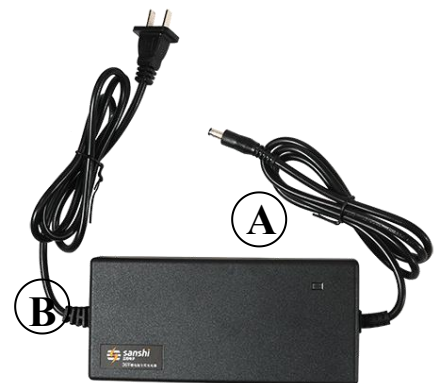

Figure 10 Charger

V. BATTERIES AND CHARGING



Warning! The battery must be charged with the charger we provide and the use of a car type battery charger is prohibited.

Warning! Please charge at the time specified in the instructions, the charger and battery voltage to match.

Warning! Do not charge at night, as charging at night is highly chargeable and overloaded, causing a fire.

Warning! Do not charge indoors and do not charge unattended.

Warning! You must use a separate charger, the current cannot exceed 5 amperes, the voltage is 36V, for more information please contact your vendor.

Warning! Don't try to buy retrofitted/hybrid batteries cheaply, they are reassembled with cores that are past their useful life and carry safety risks.

Warning! Do not use miscellaneous batteries, do not use non-compliant wires and connectors in parallel batteries in parallel without factory guidance

prompt! When your input power supply is not close to C7 PRO you can remove the battery, get near the power supply, the same can be charged, but put back the battery must be connected correctly, the battery base is tight, see remove the battery.

Improve battery use

For maximum battery performance, be aware of:

- 1, before the first use, please fully charge the new battery, which can make the battery performance to a higher value.
- 2, use the handbike at home, start moving slowly, do not leave too far, unless you are already proficient in using the drive head and can judge the stroke according to the battery level:

Charging frequency

Many factors affect the charging cycle, which you may use daily or only once a few weeks.

- 1, daily use

If you use C7 every day and charge it immediately after the end of the day, C7 can be used all day. We recommend charging for 6-10 hours, not more than 12 hours.

- 2, occasionally use

If you don't use it very often (once a week or less), you should charge at least once a week for 6 to 10 hours.

If you plan not to use handbike for a longer period of time, you should charge the battery before storing it. Store the C7 in a warm, dry environment to avoid extreme temperatures, such as freezing cold and heat, and do not charge the icy battery.

prompt! If your handbike to be kept for a period of time, it is recommended that you place a plank under the bracket to isolate the floor from the ground and avoid tire contact with the ground.

note! Keep the battery dry and avoid deep discharge, no more than 12 hours on one charge.

Other relevant information about the battery:

- 1, why the new battery working ability is very weak?

We have a close relationship with the battery supplier, who provides us with the best C7 battery. At the factory, the new battery is fully charged, and during transit, extreme temperatures may affect their initial performance, excessive temperatures can reduce

V. BATTERIES AND CHARGING

battery power, low temperatures can reduce power utilization, and extend battery charging time (like car batteries), which can take several days to stabilize the battery temperature and adjust to the new ambient temperature.

Proper charging is beneficial for batteries.

note! The life of the battery is related to its maintenance.

2, how to store the handbike and battery?

If you don't use C7 very often, we recommend that you maintain the battery at least once a month.

If you plan not to use C7 for a longer period of time, you should charge the battery before storing it. Unplug the battery cable and store the C7 in a warm, dry environment to avoid extreme temperatures, such as freezing cold and heat, and do not charge the frozen battery.

3, how to transport?

We recommend that you contact your shipping company to further confirm the shipping specifications. If you want a foreign company to ship C7 to your destination, it is recommended to recapitate the original packaging of the C7 and pack your battery in separate packaging.

Troubleshooting:

Fault	The cause of the failure	The exclusion method
The charger does not charge properly	<ol style="list-style-type: none"> 1、 Damage to the power cord or loss of the socket; 2、 Charger fuse blown; 3、 The connection battery wiring is off. 	<ol style="list-style-type: none"> 1、 Repair power cords or fasten sockets; 2、 Replace the same type of fuse; 3、 Plug in the various cables.
Charging is NORMAL, but there is not enough range	<ol style="list-style-type: none"> 1、 Disc brake adjustment is too tight; 2、 Long-term high-speed driving or the formation of uphill, headwinds, brake start too often; 3、 The battery is aging or damaged. 	<ol style="list-style-type: none"> 1、 Adjust the brake cable looseness appropriately; 2、 Avoid long-term high-speed driving and frequent braking; 3、 Replace or repair the battery.
The drive motor is not working properly	<ol style="list-style-type: none"> 1、 Cable connections such as batteries, motors, controllers, etc. are loose or fall off. 	<ol style="list-style-type: none"> 1, check the battery, motor, controller and other cables, reconnect strongly.

VI. Maintenance

The C7 is a mature electric handbike like other electric cars, requires regular maintenance. You can do some routine checks yourself, while others are assisted by the dealer. Maintenance is very important, and if you follow the schedule of maintenance checks in this section, you can use C7 for years with ease and pleasure. Contact your C7 dealer for any questions about C7 maintenance or operation.



Warning! Your C7 is as vulnerable to the natural environment as most electrical or mechanical equipment. In any case, avoid wet environments, direct contact with water or humid environments may lead to electrical or mechanical failure of handbike, water can lead to corrosion of electronic components, frame rust.

Is your C7 in contact with water?

- 1, with a rag as far as possible to dry the water;
- 2, put C7 in a warm and dry place, so that the water evaporates;
- 3, before use to carry out all safety and operational tests;
4. If you find any anomalies, contact your C7 dealer.

First, General guidance

Avoid hitting the handbike;

Avoid prolonged exposure to harsh conditions, such as overheating, coldness or humidity;

Keep the handbike clean; .

Check all electrical connections to ensure that they are fastened and safe, while checking the cable connection of the charger;

When the lights of the battery status table are fully lit, the battery is fully charged and the system is working properly:

If the battery status table has a red light slowly flashing, indicating that the battery is low, need to charge;

- ◆ Check all cable connections to ensure that they are tight and not corroded and that the batteries must be placed in the battery area and leveled;
- ◆ All wheel bearings are lubricated and sealed and do not require the addition of lubricants.

Second, Product inspection

1, daily check:

Turn off the power, check the buttons, make sure there is no bending and breakage, and make sure you are in place when you let it go;

- ◆ Make a visual inspection of the cables to make sure they are free of cracks or breaks or exposed wires. If you have any problems with the cable, please contact your supplier.

◆ 2, weekly check:

Check if the battery base is broken, just check the base for appearance and do not dispose of or repair it. If you have questions, please contact your supplier;

Make sure that all parts of the handbike is tightly connected and do not tighten the screws too tightly. .

Check the brakes, this inspection must be carried out on the horizontal surface, there must be open space 1.5 meters around.

Check the brakes:

Note: When this test is performed, Q7 PRO moves.

VI. Maintenance

- 1, turn on the power;
- 2, check the battery status table, to ensure that the battery has electricity;
- 3, slowly push forward the acceleration button, line out a certain distance after the brake, see if the brake distance is too long.

3, monthly check:

Check the wear of the handbike, if necessary for repair, please contact your supplier;

- ◆ Keep C7 PRO clean and free of clutter such as hair, food, drinks, residues, etc. Annual inspections to dealers for routine annual inspections will ensure that your C7 PRO function is working properly and that problems are avoided.

Third, Replace the battery

- 1, to ensure that the handbike is in a shutdown state;
- 2, remove the battery details see "remove the battery";
3. Plug down the NEW battery.

Note: It is important to ensure that your battery base is securely connected. prompt! Please dispose of your old batteries according to local waste disposal.

Fourth, Corrective maintenance

If the battery status light is not on:

Check the battery base to ensure tight connection;

Check the circuit switch, if necessary, please restart;

If all of the above checks are correct, the battery can be checked with the battery capacity tester. Testers are available in automated instrument stores. Open the battery connection before testing, follow the instructions that came with the tester, and replace it if the battery test results are poor. If C7 still does not provide power, contact your dealer.

Fifth. Other related circumstances

1, temperature

Some parts of the handbikes are susceptible to temperature

At extremely low temperatures, the battery may freeze. There are many factors that can cause freezing at special temperatures, such as charger type, usage, and battery composition (e.g. sealed lead-acid batteries or gel batteries);

The temperature is too high may slow down the handbike.

2, storage:

C7 should be stored in a dry environment, not placed at the extreme temperature, when stored, the battery should be removed, understand the structure, if not stored under the above conditions, may cause rust of the scaffolding and electrical system damage.

3, cleaning:

Do not rinse C7 with water or come into direct contact with water;

C7 can be easily wiped clean with a damp cloth, do not use chemical agents to clean;

4, under what circumstances need to provide services

The following may indicate a serious problem with your C7 and if necessary, contact your supplier. Before you call, please have information data such as the model number, serial number, type of fault, etc.

- ◆ Excessive motor noise
- ◆ The wires are severely frayed
- ◆ Unable to run
- ◆ There is electricity supply, but the car cannot be started.
- ◆ Tilt to one side
- ◆ The connectors are severely cracked or broken
- ◆ Severe tire wear
- ◆ Severe shaking occurs

VII. Safety driving important matters

To ensure that you can use the appliance safely, be sure to follow these requirements when using it correctly:

1. Before the first drive, be sure to conduct driving exercises in an open space and be fully proficient in the product acceleration, deceleration, braking and other performance before driving on the road.
2. Travel on the road in accordance with traffic rules, it is recommended to maintain moderate speed, if driving at the top speed will not only consume electricity will increase dramatically, reduce the range, but also reduce the safety factor. Please drive on non-motorized roads and do not enter motorized lanes.
3. Be sure to choose a flat road surface while driving, if you need to overcome road obstacles, you must keep the two wheels of the wheelchair to cross at the same time, otherwise it is very easy to produce rollover phenomenon.
4. When driving in indoor environments such as crowded or supermarkets, you must keep driving at low speed and control the braking distance.

When turning, the speed must not exceed 2km/h. ☆

5. This product should not be used in rainy environment, driving as far as possible to avoid wading, wading caused by the fault is not covered by the warranty.
6. This product is not easy to be in confined space, do not enter elevators, homes and subway stations, to prevent possible accidents.
7. Always turn off the power switch while not driving to prevent children and others from mishandling.
8. Before driving, make sure that the battery power switch is on (for 15AH battery handbike).
9. Make sure that the quick pin falls completely into the corresponding hole.
10. Before driving, make sure that all screws, etc. are tightened.
11. Do not modify the meter data at will until you are familiar with your handbike.

VIII. Quality assurance

Quality warranty coverage

Wisking provides quality warranty service for the following accessories:

- ◆ Main frame (one-year warranty)
- ◆ Drive assembly (one-year warranty)
- ◆ Charger (one-year warranty)
- ◆ Wheels (one-year warranty).
- ◆ Battery(one-year warranty, failure to charge in a timely manner resulting in a loss of power or natural decline in power storage capacity is not covered by the warranty);
- ◆ Bearings, bushings, switches, etc. are consumable parts (manufacturers provide a three-month warranty);

Note: The above accessories by external force collision, water, fluid, without the authorization of Wisking self-modification, self-removal are not covered by the warranty.

Out of warranty

- ◆ All plastic and rubber parts are consumables and are not covered by the warranty;
- ◆ Tires and housings are not covered by the warranty;
- ◆ Decoration and seating;
- ◆ Repair and modification of any part without the express consent of Wisking in advance;
- ◆ No special approval of Wisking for maintenance of labor, telephone charges, freight and other costs;
- ◆ Caused by man-made destruction;
- ◆ Battery fluid overflow and leakage;
- ◆ Damage caused by abuse, mishandling, accident and negligence;
- ◆ Damage caused by incorrect operation, maintenance and storage;
- ◆ Caused by the private replacement of batteries and chargers;
- ◆ Products used as a substitute, if changed to commercial or other purposes and overload and oversized slope, etc. are not covered by the warranty;

None of the above is covered by the warranty.

If there is a contradiction between the previous warranty terms, this clause prevails.

Note: To obtain a product warranty, the customer must provide the exact product serial number!

Shanghai Wisking Electric Machine Co., Ltd

This warranty is in place from August, 2025